

Adams

Constant
Level
Oilers

Huileurs
à Niveau
Constant

Ölstandsregler
(Constant
Level Öler)



Constant Level Oilers

Widely used in the chemical and process industries, constant level oilers maintain a constant fluid level at all times. Available with BSP or NPT thread. Plastic or glass reservoirs with capacities of 85 cc to 500 cc.

Huileurs à Niveau Constant

Largement répandus dans les industries chimiques et de process, les huileurs à niveau constant assurent en permanence un niveau constant de liquide. Fournis en filetage BSP ou NPT, avec réservoirs en verre ou en plastique ils sont disponibles en capacité de 85 cm³ à 500 cm³.

Ölstandsregler (Constant Level Öler)

Diese Öler halten das gewünschte Niveau der Flüssigkeit immer konstant. Eingesetzt werden sie vor allem in der chemischen Industrie und der Verfahrenstechnik. Lieferbar sind diese Öler von 85 ml bis 500ml, mit Behältern aus Glas oder Plexiglas, Anschlußgewinde Rohrgewinde oder NPT.

ALUMINIUM ALLOY BODY - PLASTIC BOTTLE

Product No	A	B	C	D	E	Capacity
ACL 7567	51	82	1/4 BSP	7	51	85 ml
ACL 7568	51	82	1/4 NPT	7	51	85 ml
ACL 7572	57	87	1/4 BSP	7	51	115 ml
ACL 7573	57	87	1/4 NPT	7	51	115 ml
ACL 7577	64	94	1/4 BSP	7	51	158 ml
ACL 7578	64	94	1/4 NPT	7	51	158 ml

Maximum operating temperature 65° C
Finish - ZINC PLATE

STEEL BODY - PLASTIC BOTTLE

Product No	A	B	C	D	E	Capacity
ACL 7563	51	82	1/8 BSP	7	51	85 ml
ACL 7564	51	82	1/8 NPT	7	51	85 ml
ACL 7579	51	82	1/4 BSP	7	51	85 ml
ACL 7580	51	82	1/4 NPT	7	51	85 ml
ACL 7581	57	87	1/4 BSP	7	51	115 ml
ACL 7582	57	87	1/4 NPT	7	51	115 ml
ACL 7583	64	94	1/4 BSP	7	51	158 ml
ACL 7584	64	94	1/4 NPT	7	51	158 ml

Maximum operating temperature 65° C
Finish - ZINC PLATE

ALUMINIUM ALLOY BODY - GLASS BOTTLE

Product No	A	B	C	D	E	Capacity
ACL 7595	61	92	1/4 BSP	7	51	120 ml
ACL 7596	61	92	1/4 NPT	7	51	120 ml

Maximum operating temperature 100° C
Finish - ZINC PLATE

STEEL BODY - GLASS BOTTLE

Product No	A	B	C	D	E	Capacity
ACL 7597	61	92	1/4 BSP	7	51	120 ml
ACL 7598	61	92	1/4 NPT	7	51	120 ml

Maximum operating temperature 100° C
Finish - ZINC PLATE

ACL 7595/2 spare glass 120 ml

BAYONET TYPE - PLASTIC BOTTLE

Product No	A	B	C	D	E	Capacity
ABL 7528	51	93	1/4 BSP	7	51	85 ml
ABL 7538	64	104	1/4 BSP	7	51	158 ml

Maximum operating temperature 65° C
Finish - ZINC PLATE

WIRE GUARD for 120 ml capacity oiler

Product No	A	B	C	D	E
	mm	mm	mm	mm	mm
WG 120	60.3	61.9	62.7	6.35	25.4

Material - STEEL Finish - ZINC PLATE

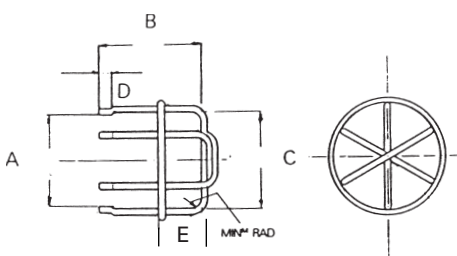
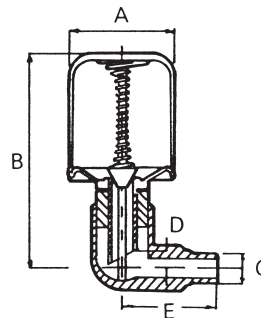
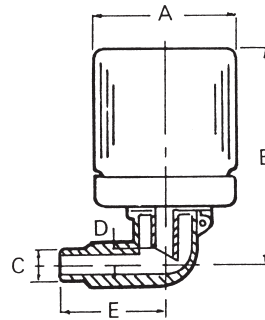
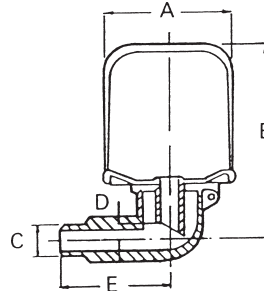

BASE ENTRY - GLASS BOTTLE

Product No	A mm	B		D	E mm	Capacity
		Min	Max			
VABL 7974	61	132	142	1/4 NPT	26	120 ml
VABL 7983	61	132	142	1/4 BSP	26	120 ml
VABL 7977	64	189	199	1/4 NPT	26	220 ml
VABL 7986	64	189	199	1/4 BSP	26	220 ml
VABL 7980	82	217	227	1/4 NPT	26	500 ml
VABL 7989	82	217	227	1/4 BSP	26	500 ml

Maximum operating temperature - 100° C
Material - STEEL BODY Finish - ZINC PLATE

SIDE ENTRY - GLASS BOTTLE

Product No	A mm	B		C mm	D	E mm	Capacity
		Min	Max				
VABL 7973	61	132	142	33	1/4 NPT	26	120 ml
VABL 7982	61	132	142	33	1/4 BSP	26	120 ml
VABL 7976	64	189	199	33	1/4 NPT	26	220 ml
VABL 7985	64	189	199	33	1/4 BSP	26	220 ml
VABL 7979	82	222	232	33	1/4 NPT	26	500 ml
VABL 7988	82	222	232	33	1/4 BSP	26	500 ml

Maximum operating temperature - 100° C
Material - STEEL BODY Finish - ZINC PLATE

VABL 7976/2 spare glass 220 ml

VABL 7979/1 spare glass 500 ml

SIDE ENTRY - PLASTIC BOTTLE

Product No	A mm	B		C mm	D	Capacity ml
		Min	Max			
VABL 7970	63.5	135	145	33	1/4 NPT	158
VABL 7991	63.5	135	145	33	1/4 BSP	158

Maximum operating temperature 65° C
Material - STEEL BODY Finish - ZINC PLATE

BASE ENTRY - PLASTIC BOTTLE

Product No	A mm	B		D	Capacity ml
		Min	Max		
VABL 7971	63.5	135	145	1/4 NPT	158
VABL 7992	63.5	135	145	1/2 BSP	158

Maximum operating temperature 65° C
Material - STEEL BODY Finish - ZINC PLATE

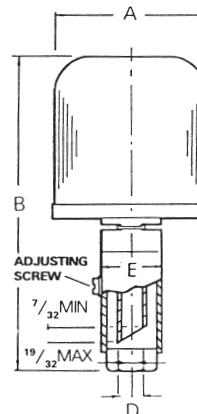
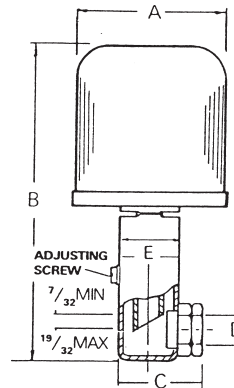
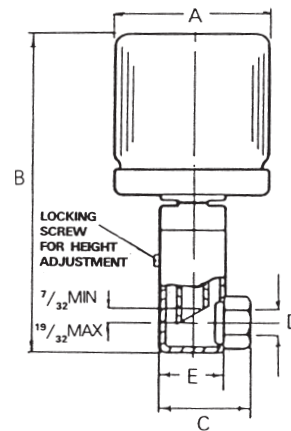
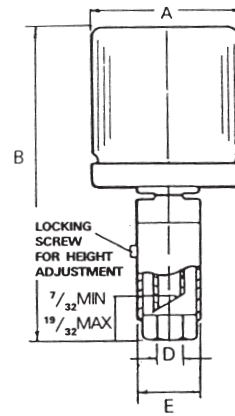
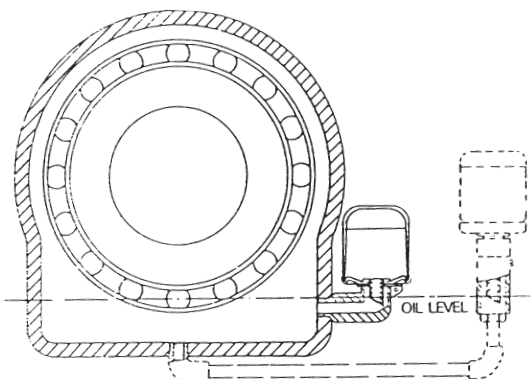

Height adjustment -
Min 7/32 (5.5mm)
Max 19/32 (15mm)

TYPICAL APPLICATION

Constant level oilers, depending on type are mounted into either oil level plug or drain plug holes. The cut-off tube MUST be vertical. Final oil level adjustments can be made by filing the cut-off tube or in the case of the VABL by the adjustment screw. To ensure the correct oil level, the gearbox MUST be filled using the oil feeder tube of the constant level.

AUTOMATIC OPEN VENT

Dimension in mm

Product No	A	B	C	D	E
RCL 7780	85	100	60	1/4 BSP	30

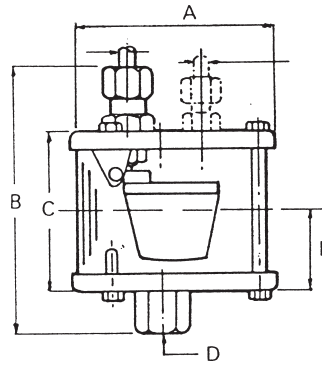

PORTED VENT

Dimension in mm

Product No	A	B	C	D	E
RCL 7781	85	100	60	1/4 BSP	30

Material - STEEL, GLASS Finish - ZINC PLATE

RESERVOIRS

Dimensions in mm

Product No	Capacity	A	B	C	D	E	F	G	H	J	K	Material	Finish
LV 10640	2 litre	155	142	150	198	200	125	32	-	7	3/8 BSP	Aluminium	Silver
LV 10641	2.7 litre	155	142	157	205	213	125	32	-	7	3/8 BSP	Plastic	Natural
LV 10642	5 litre	248	174	157	228	236	218	15	40	8	3/8 BSP	Aluminium	Silver
LV 10644	8 litre	362	185	180	273	281	333	15	40	8	3/8 BSP	Steel	Silver

Add suffix "FS" if low level switch required

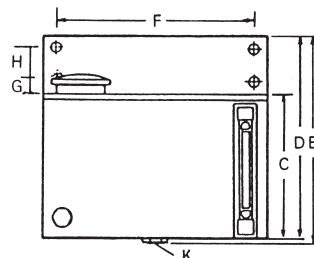
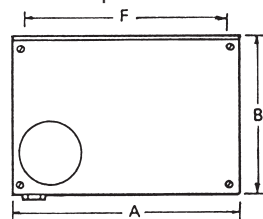

ON/OFF VALVES

MANUALLY OPERATED NICKEL PLATED BRASS BODY

Product No	A	B	C	D	E	F
LV 10521	1/4 BSP	39	38	22	8	21

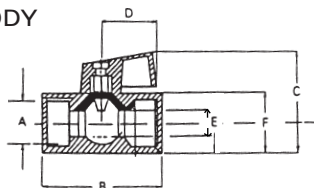

ELECTRIC SOLENOID OPERATED

Product No	Voltage	A	B	C	D	Thread
LV 10523	110. 50	82	35	79	32	
LV 10524	240. 50	82	35	79	32	1/4 BSP
LV 10525	440. 50	82	35	79	32	

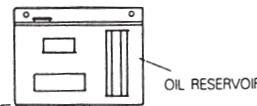
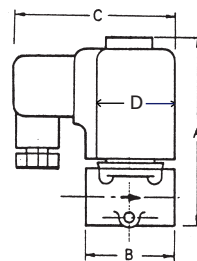

AUTOMATIC CONSTANT LEVEL SYSTEMS

The advantages of having the Adams RCL 7780 constant level oiler incorporates a float operated "shut-off" valve enabling it to be filled from a central reservoir. As the pump loses oil, the pump and the constant level oiler reservoir levels fall. The valve in the RCL opens taking oil from the central reservoir, when the correct oil level is reached, the float closes the valve. The system is gravity fed using the central reservoir as a header tank. Any number of pumps can be incorporated into an automatic constant level system.

